















































## トラバースガイド

YM-92CW (ECONOMY TYPE)			
【 POY 】 Plastic material - PA-F		【 FDY 】 Plastic material - PA-H	
Surface finish - NORMAL	Surface finish - DP	Surface finish - NORMAL	Surface finish - DP
		 <p>W = 1.0 D = ~300 No. B610015</p> <p>[ TMT ]</p>	 <p>W = 1.0 D = ~300 No. B610015-A</p> <p>[ TMT ]</p>
		 <p>W = 1.5 D = 250~600 No. B804015</p> <p>[ TMT ]</p>	 <p>W = 1.5 D = 250~600 No. B804015-A</p> <p>[ TMT ]</p>
		 <p>W = 1.0 D = ~300 No. C408020</p> <p>[ TMT BEIJING BARMAG ]</p>	 <p>W = 1.0 D = ~300 No. C408020-A</p> <p>[ TMT BEIJING BARMAG ]</p>
		 <p>W = 1.0 D = ~300 No. B901010</p> <p>[ TMT BEIJING BARMAG ]</p>	 <p>W = 1.0 D = ~300 No. B901010-A</p> <p>[ TMT BEIJING BARMAG ]</p>
		 <p>W = 1.5 D = 250~600 No. B901020</p> <p>[ TMT BEIJING BARMAG ]</p>	 <p>W = 1.5 D = 250~600 No. B901020-A</p> <p>[ TMT BEIJING BARMAG ]</p>
		 <p>W = 1.0 D = ~300 No. B610040</p> <p>[ TMT BEIJING BARMAG ]</p>	 <p>W = 1.0 D = ~300 No. B610040-A</p> <p>[ TMT BEIJING BARMAG ]</p>
		 <p>W = 1.5 D = 250~600 No. B804040</p> <p>[ TMT BEIJING BARMAG ]</p>	 <p>W = 1.5 D = 250~600 No. B804040-A</p> <p>[ TMT BEIJING BARMAG ]</p>
 <p>W = 1.0 D = ~300 No. B610005</p> <p>[ MURATA BEIJING ]</p>	 <p>W = 1.0 D = ~300 No. B610005-A</p> <p>[ MURATA BEIJING ]</p>	 <p>W = 1.0 D = ~300 No. C108010</p> <p>[ MURATA BEIJING ]</p>	 <p>W = 1.0 D = ~300 No. C108010-A</p> <p>[ MURATA BEIJING ]</p>
 <p>W = 1.5 D = 250~600 No. B804005</p> <p>[ MURATA BEIJING ]</p>	 <p>W = 1.5 D = 250~600 No. B804005-A</p> <p>[ MURATA BEIJING ]</p>		

# YM-99C (STANDARD TYPE)

【 POY 】 Plastic material - PA-F		【 FDY 】 Plastic material - PA-H	
Surface finish - NORMAL	Surface finish - DP	Surface finish - NORMAL	Surface finish - DP
		 <p>W = 0.8 D = ~300 No. B303015</p> <p style="text-align: center;">[ TMT ]</p>	 <p>W = 0.8 D = ~300 No. B303015-A</p> <p style="text-align: center;">[ TMT ]</p>
		 <p>W = 1.2 D = 250~500 No. B402015</p> <p style="text-align: center;">[ TMT ]</p>	 <p>W = 1.2 D = 250~500 No. B402015-A</p> <p style="text-align: center;">[ TMT ]</p>
		 <p>W = 0.8 D = ~300 No. C604020</p> <p style="text-align: center;">[ TMT BEIJING BARMAG ]</p>	 <p>W = 0.8 D = ~300 No. C604020-A</p> <p style="text-align: center;">[ TMT BEIJING BARMAG ]</p>
		 <p>W = 1.2 D = 250~500 No. C606001</p> <p style="text-align: center;">[ TMT BEIJING BARMAG ]</p>	 <p>W = 1.2 D = 250~500 No. C606001-A</p> <p style="text-align: center;">[ TMT BEIJING BARMAG ]</p>
 <p>W = 0.8 D = ~300 No. C002030</p> <p style="text-align: center;">[ TMT BEIJING BARMAG ]</p>	 <p>W = 0.8 D = ~300 No. C002030-A</p> <p style="text-align: center;">[ TMT BEIJING BARMAG ]</p>	 <p>W = 0.8 D = ~300 No. B901001</p> <p style="text-align: center;">[ TMT BEIJING BARMAG ]</p>	 <p>W = 0.8 D = ~300 No. B901001-A</p> <p style="text-align: center;">[ TMT BEIJING BARMAG ]</p>
		 <p>W = 1.2 D = 250~500 No. C008049</p> <p style="text-align: center;">[ TMT BEIJING BARMAG ]</p>	 <p>W = 1.2 D = 250~500 No. C008049-A</p> <p style="text-align: center;">[ TMT BEIJING BARMAG ]</p>
 <p>W = 0.8 D = ~300 No. D009034</p> <p style="text-align: center;">[ TMT BEIJING BARMAG ]</p>	 <p>W = 0.8 D = ~300 No. D009034-A</p> <p style="text-align: center;">[ TMT BEIJING BARMAG ]</p>	 <p>W = 0.8 D = ~300 No. B302040</p> <p style="text-align: center;">[ TMT BEIJING BARMAG ]</p>	 <p>W = 0.8 D = ~300 No. B302040-A</p> <p style="text-align: center;">[ TMT BEIJING BARMAG ]</p>
 <p>W = 0.8 D = ~300 No. B303005</p> <p style="text-align: center;">[ MURATA BEIJING ]</p>	 <p>W = 0.8 D = ~300 No. B303005-A</p> <p style="text-align: center;">[ MURATA BEIJING ]</p>	 <p>W = 0.8 D = ~300 No. C709005</p> <p style="text-align: center;">[ MURATA BEIJING ]</p>	 <p>W = 0.8 D = ~300 No. C709005-A</p> <p style="text-align: center;">[ MURATA BEIJING ]</p>
 <p>W = 1.2 D = 250~500 No. B402005</p> <p style="text-align: center;">[ MURATA BEIJING ]</p>	 <p>W = 1.2 D = 250~500 No. B402005-A</p> <p style="text-align: center;">[ MURATA BEIJING ]</p>	 <p>W = 1.2 D = 250~500 No. C804005</p> <p style="text-align: center;">[ MURATA BEIJING ]</p>	 <p>W = 1.2 D = 250~500 No. C804005-A</p> <p style="text-align: center;">[ MURATA BEIJING ]</p>

OILING GUIDE - INTER LACER  
 TRAVERSE GUIDE  
 SNAIL GUIDE - DOG TAIL GUIDE  
 HOOK GUIDE - SLIT GUIDE  
 TWIST STOP WHEEL  
 ROLLER GUIDE  
 CREEL PARTS  
 GUIDE etc.  
 BEARING ROLLER GUIDE  
 BAR GUIDE - PIPE GUIDE  
 EYELET GUIDE - TUBE GUIDE  
 TENSION WASHER  
 BOBBIN CAP  
 TENSOR  
 YARN SENSOR  
 OTHER

# TRAVERSE GUIDE トラバースガイド

OILING GUIDE -  
 INNER LACER  
 TRAVERSE  
 GUIDE  
 SNAIL GUIDE -  
 DOG TAIL GUIDE  
 HOOK GUIDE -  
 SLIT GUIDE  
 TWIST STOP  
 WHEEL  
 ROLLER GUIDE  
 GREEL PARTS  
 GUIDE etc.  
 BEARING  
 ROLLER GUIDE  
 BAR GUIDE -  
 PIPE GUIDE  
 EYELET GUIDE -  
 TUBE GUIDE  
 TENSION  
 WASHER  
 BOBBIN CAP  
 TENSOR  
 YARN SENSOR  
 OTHER

**No./図番** B802001-A

**MATERIAL/材質** YM-99C・PA-H  
**weight/重量** 0.35g  
**SURFACE/表面仕上げ** NF DP HF HF2

W=0.8

**No./図番** B302040

**MATERIAL/材質** YM-99C・PA-H  
**weight/重量** 0.40g  
**SURFACE/表面仕上げ** NF DP HF HF2

W=0.8

**No./図番** C006006

**MATERIAL/材質** YM-92CW・PA-H  
**weight/重量** 0.35g  
**SURFACE/表面仕上げ** NF DP HF HF2

W=1.0

**No./図番** B610040

**MATERIAL/材質** YM-92CW・PA-H  
**weight/重量** 0.40g  
**SURFACE/表面仕上げ** NF DP HF HF2

W=1.0

**No./図番** B804040

**MATERIAL/材質** YM-92CW・PA-H  
**weight/重量** 0.40g  
**SURFACE/表面仕上げ** NF DP HF HF2

W=1.5

**No./図番** C604020

**MATERIAL/材質** YM-99C・PA-H  
**weight/重量** 0.45g  
**SURFACE/表面仕上げ** NF DP HF HF2

W=0.8

**No./図番** C408020

**MATERIAL/材質** YM-92CW・PA-H  
**weight/重量** 0.45g  
**SURFACE/表面仕上げ** NF DP HF HF2

W=1.0

**No./図番** C606001

**MATERIAL/材質** YM-99C・PA-H  
**weight/重量** 0.45g  
**SURFACE/表面仕上げ** NF DP HF HF2

W=1.2

**No./図番** B901001

**MATERIAL/材質** YM-99C·PA-H  
**weight/重量** 0.45g  
**SURFACE/表面仕上げ** NF DP HF HF2

W=0.8

**No./図番** B901010

**MATERIAL/材質** YM-92CW·PA-H  
**weight/重量** 0.45g  
**SURFACE/表面仕上げ** NF DP HF HF2

W=1.0

**No./図番** C008049

**MATERIAL/材質** YM-99C·PA-H  
**weight/重量** 0.45g  
**SURFACE/表面仕上げ** NF DP HF HF2

W=1.2

**No./図番** B901020

**MATERIAL/材質** YM-92CW·PA-H  
**weight/重量** 0.45g  
**SURFACE/表面仕上げ** NF DP HF HF2

W=1.5

**No./図番** B303005

**MATERIAL/材質** YM-99C·PA-F  
**weight/重量** 0.60g  
**SURFACE/表面仕上げ** NF DP HF HF2

W=0.8

**No./図番** A001030

**MATERIAL/材質** YM-99C·PA-F  
**weight/重量** 0.60g  
**SURFACE/表面仕上げ** NF DP HF HF2

W=0.8

**No./図番** B610005

**MATERIAL/材質** YM-92CW·PA-F  
**weight/重量** 0.60g  
**SURFACE/表面仕上げ** NF DP HF HF2

W=1.0

**No./図番** B402005

**MATERIAL/材質** YM-99C·PA-F  
**weight/重量** 0.60g  
**SURFACE/表面仕上げ** NF DP HF HF2

W=1.2

- TRAVEL GUIDE
- INTER LACER
- TRAVERSE GUIDE
- SNAIL GUIDE
- DOG TAIL GUIDE
- HOOK GUIDE
- SPLIT GUIDE
- HOOK GUIDE
- SLIT GUIDE
- TWIST STOP
- WHEEL
- ROLLER GUIDE
- ROLLER GUIDE
- CREEL PARTS
- GUIDE etc.
- BEARING
- ROLLER GUIDE
- BAR GUIDE
- PIPE GUIDE
- PIPE GUIDE
- EYELET GUIDE
- TUBE GUIDE
- EYELET GUIDE
- TUBE GUIDE
- TENSION
- WASHER
- ROBBIN CAP
- TENSOR
- TENSOR
- YARN SENSOR
- YARN SENSOR
- OTHER
- OTHER

# TRAVERSE GUIDE トラバースガイド

OILING GUIDE-  
 INNER LACER  
 TRAVERSE  
 GUIDE  
 SNAIL GUIDE-  
 DOG TAIL GUIDE  
 HOOK GUIDE-  
 SLIT GUIDE  
 TWIST STOP  
 WHEEL  
 ROLLER GUIDE  
 GREEL PARTS  
 GUIDE etc.  
 BEARING  
 ROLLER GUIDE  
 BAR GUIDE-  
 PIPE GUIDE  
 EYELET GUIDE-  
 TUBE GUIDE  
 TENSION  
 WASHER  
 BOBBIN CAP  
 TENSOR  
 YARN SENSOR  
 OTHER

**No./図番** **B804005**

**MATERIAL/材質** YM-92CW・PA-F  
**weight/重量** 0.60g  
**SURFACE/表面仕上げ** NF DP HF HF2

W=1.5

**No./図番** **C709005**

**MATERIAL/材質** YM-99C・PA-H  
**weight/重量** 0.60g  
**SURFACE/表面仕上げ** NF DP HF HF2

W=0.8

**No./図番** **C108010**

**MATERIAL/材質** YM-92CW・PA-H  
**weight/重量** 0.60g  
**SURFACE/表面仕上げ** NF DP HF HF2

W=1.0

**No./図番** **C804005**

**MATERIAL/材質** YM-99C・PA-H  
**weight/重量** 0.60g  
**SURFACE/表面仕上げ** NF DP HF HF2

W=1.2

**No./図番** **B610030**

**MATERIAL/材質** YM-99C・PA-F  
**weight/重量** 1.00g  
**SURFACE/表面仕上げ** NF DP HF HF2

W=0.8

**No./図番** **B606060**

**MATERIAL/材質** YM-92CW・PA-F  
**weight/重量** 1.00g  
**SURFACE/表面仕上げ** NF DP HF HF2

W=1.0

**No./図番** **A811030**

**MATERIAL/材質** YM-99C・PA-F  
**weight/重量** 1.10g  
**SURFACE/表面仕上げ** NF DP HF HF2

W=1.0

**No./図番** **B804060**

**MATERIAL/材質** YM-92CW・PA-F  
**weight/重量** 1.00g  
**SURFACE/表面仕上げ** NF DP HF HF2

W=1.5

**No./図番** **A812011**

MATERIAL/材質	YM-99C·PA-F			
weight/重量	1.20g			
SURFACE/表面仕上げ	NF	DP	HF	HF2

W=2.0

**No./図番** **B610055**

MATERIAL/材質	YM-99C·PA-F			
weight/重量	0.60g			
SURFACE/表面仕上げ	NF	DP	HF	HF2

W=0.8

**No./図番** **B610010**

MATERIAL/材質	YM-92CW·PA-F			
weight/重量	0.60g			
SURFACE/表面仕上げ	NF	DP	HF	HF2

W=1.0

**No./図番** **B303010**

MATERIAL/材質	YM-99C·PA-F			
weight/重量	0.80g			
SURFACE/表面仕上げ	NF	DP	HF	HF2

W=1.0

**No./図番** **B408032**

MATERIAL/材質	YM-99C·PA-F			
weight/重量	1.50g			
SURFACE/表面仕上げ	NF	DP	HF	HF2

W=0.4

**No./図番** **C002001**

MATERIAL/材質	YM-99C·PA-F			
weight/重量	1.20g			
SURFACE/表面仕上げ	NF	DP	HF	HF2

W=0.8

**No./図番** **C806030**

MATERIAL/材質	YM-99C·PA-F			
weight/重量	1.20g			
SURFACE/表面仕上げ	NF	DP	HF	HF2

W=1.2

**No./図番** **B904003**

MATERIAL/材質	YM-92CW·PA-F			
weight/重量	0.40g			
SURFACE/表面仕上げ	NF	DP	HF	HF2

- OLLING GUIDE - INTER LACER
- TRAVERSE GUIDE
- SNAIL GUIDE - DOG TAIL GUIDE
- HOOK GUIDE - SLIT GUIDE
- TWIST STOP WHEEL
- ROLLER GUIDE
- CREEL PARTS
- GUIDE etc.
- BEARING ROLLER GUIDE
- BAR GUIDE - PIPE GUIDE
- EXLET GUIDE - TUBE GUIDE
- TENSION WASHER
- BOBBIN CAP
- TENSOR
- YARN SENSOR
- OTHER

# TRAVERSE GUIDE トラバースガイド

CLING GUIDE-  
INNER LACER

TRAVERSE  
GUIDE

SNAIL GUIDE-  
DOG TAIL GUIDE

HOOK GUIDE-  
SLIT GUIDE

TWIST STOP  
WHEEL

ROLLER GUIDE

CREEL PARTS

GUIDE etc.

BEARING  
ROLLER GUIDE

BAR GUIDE-  
PIPE GUIDE

EYELET GUIDE-  
TUBE GUIDE

TENSION  
WASHER

BOBBIN CAP

SENSOR

YARN SENSOR

OTHER

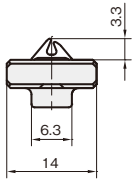
No./図番	<b>B805001</b>	
		
		
MATERIAL/材質	YM-92CW·PA-F	W=1.5
weight/重量	0.45g	
SURFACE/表面仕上げ	NF DP HF HF2	

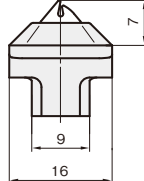
No./図番	<b>C108004</b>	
		
		
MATERIAL/材質	YM-99C·PA-H	W=0.8
weight/重量	1.10g	
SURFACE/表面仕上げ	NF DP HF HF2	

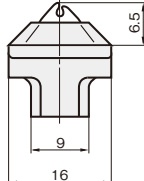
No./図番	<b>C002002</b>	
		
		
MATERIAL/材質	YM-92CW·PA-F	W=1.0
weight/重量	1.20g	
SURFACE/表面仕上げ	NF DP HF HF2	

No./図番	<b>D308025</b>	
		
		
MATERIAL/材質	YM-99C·PA-H	W=1.0
weight/重量	1.35g	
SURFACE/表面仕上げ	NF DP HF HF2	

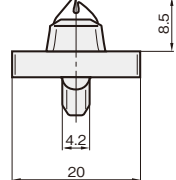
No./図番	<b>B303015</b>	
		
		
MATERIAL/材質	YM-99C·PA-H	W=0.8
weight/重量	1.00g	
SURFACE/表面仕上げ	NF DP HF HF2	

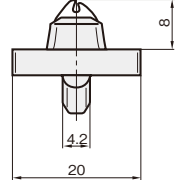
No./図番	<b>B610015</b>	
		
		
MATERIAL/材質	YM-92CW·PA-H	W=1.0
weight/重量	1.00g	
SURFACE/表面仕上げ	NF DP HF HF2	

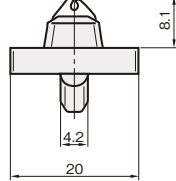
No./図番	<b>B402015</b>	
		
		
MATERIAL/材質	YM-99C·PA-H	W=1.2
weight/重量	1.00g	
SURFACE/表面仕上げ	NF DP HF HF2	

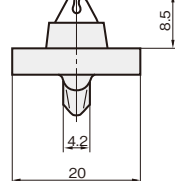
No./図番	<b>A110049</b>	
		
		
MATERIAL/材質	YM-99C·PA-H	W=1.2
weight/重量	1.20g	
SURFACE/表面仕上げ	NF DP HF HF2	





# TRAVERSE GUIDE トラバースガイド

- ILING GUIDE-  
INTER LACER
- TRAVERSE  
GUIDE
- SNAIL GUIDE-  
DOG TAIL GUIDE
- HOOK GUIDE-  
SLIT GUIDE
- TWIST STOP  
WHEEL
- ROLLER GUIDE
- GRIEL PARTS
- GUIDE etc.
- BEARING  
ROLLER GUIDE
- BAR GUIDE-  
PIPE GUIDE
- EYELET GUIDE-  
TUBE GUIDE
- TENSION  
WASHER
- BOBBIN CAP
- SENSOR
- YARN SENSOR
- OTHER

**No./図番** N810031

**MATERIAL/材質** YM-99C  
**weight/重量** 0.55g  
**SURFACE/表面仕上げ** NF DP HF HF2

**No./図番** A106050

**MATERIAL/材質** YM-99C  
**weight/重量** 0.65g  
**SURFACE/表面仕上げ** NF DP HF HF2

**No./図番** N608059

**MATERIAL/材質** YM-99C  
**weight/重量** 1.00g  
**SURFACE/表面仕上げ** NF DP HF HF2

**No./図番** C105008

**MATERIAL/材質** YM-99C  
**weight/重量** 2.70g  
**SURFACE/表面仕上げ** NF DP HF HF2

**No./図番** D404009

**MATERIAL/材質** YM-99C  
**weight/重量** 3.53g  
**SURFACE/表面仕上げ** NF DP HF HF2

**No./図番** D708018

**MATERIAL/材質** YM-99C  
**weight/重量** 0.78g  
**SURFACE/表面仕上げ** NF DP HF HF2

**No./図番** D806035

**MATERIAL/材質** YM-99C  
**weight/重量** 2.00g  
**SURFACE/表面仕上げ** NF DP HF HF2

